



DC12-55 (12V55Ah)

DC (Deep Cycle) series is specially designed for frequent cyclic discharge. By using strong grids and specially designed active material, the DC series battery offers 30% more cyclic life than the standby series. It is suitable for solar energy systems, marine and RV etc.



Specification

Cells Per Unit	6
Voltage Per Unit	12
Capacity	55Ah@10hr-rate to 1.80V per cell @25°C
Weight	Approx. 18.0 Kg (Tolerance $\pm 3\%$)
Max. Discharge Current	550 A (5 sec)
Internal Resistance	Approx. 6 m Ω
Operating Temperature Range	Discharge: -20°C~60°C Charge: 0°C~50°C Storage: -20°C~60°C
Normal Operating Temperature Range	25°C \pm 5°C
Float charging Voltage	13.6 to 13.8 VDC/unit Average at 25°C
Recommended Maximum Charging Current	16.5A
Equalization and Cycle Service	14.6 to 14.8 VDC/unit Average at 25°C
Self Discharge	RITAR Valve Regulated Lead Acid (VRLA) batteries can be stored for more than 6 months at 25°C. Self-discharge ratio less than 3% per month at 25°C. Please charge batteries before using.
Terminal	Terminal F11/F15
Container Material	A.B.S. UL94-HB, UL94-V0 Optional.



Dimensions

Unit: mm Dimension: 229(L) \times 138(W) \times 235(H)

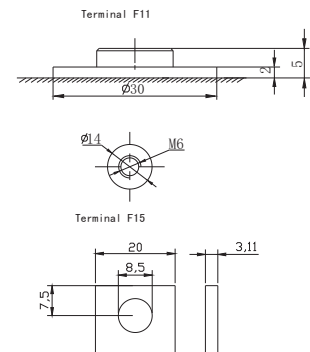
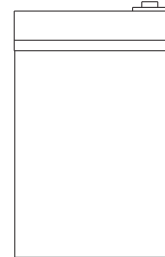
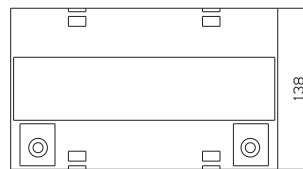
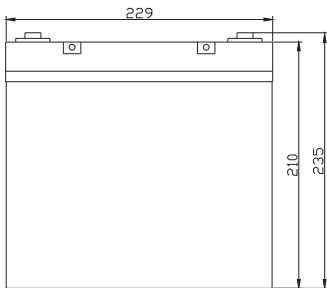

Constant Current Discharge Characteristics: A (25°C)

F.V/Time	5MIN	10MIN	15MIN	30MIN	1HR	2HR	3HR	4HR	5HR	8HR	10HR	20HR
9.60V	192.6	141.8	105.8	55.26	34.33	21.20	14.40	11.61	9.64	6.35	5.72	3.03
10.0V	187.0	134.9	103.6	54.55	33.87	20.77	14.14	11.45	9.56	6.33	5.67	2.97
10.2V	181.5	130.1	101.97	53.72	33.55	20.55	14.01	11.34	9.49	6.27	5.61	2.92
10.5V	162.9	120.1	97.09	52.24	33.14	20.28	13.89	11.17	9.41	6.21	5.56	2.86
10.8V	147.1	109.5	89.50	50.51	32.68	20.11	13.73	10.79	9.37	6.19	5.50	2.83
11.1V	125.6	97.9	80.28	48.59	31.90	19.30	13.46	10.63	9.30	6.14	5.44	2.72

Constant Power Discharge Characteristics: W (25°C)

F.V/Time	5MIN	10MIN	15MIN	30MIN	1HR	2HR	3HR	4HR	5HR	8HR	10HR	20HR
9.60V	2032	1510	1153	632.6	397.8	248.4	169.6	139.0	115.5	76.04	68.63	36.50
10.0V	1992	1464	1135	626.0	394.2	245.3	167.1	137.1	114.5	75.75	68.09	35.86
10.2V	1969	1425	1122	620.6	391.9	243.6	166.3	135.8	113.8	75.18	67.49	35.20
10.5V	1792	1327	1070	607.9	389.4	240.5	165.0	133.9	112.9	74.54	66.82	34.54
10.8V	1633	1223	989.0	593.5	384.4	238.7	163.1	129.4	112.3	74.22	66.16	34.20
11.1V	1434	1106	890.3	577.2	378.6	229.8	160.4	127.6	111.9	73.70	65.44	32.98

All mentioned values are average values (Tolerance $\pm 2\%$).

DC12-55

12V55Ah



Life characteristics of cyclic use

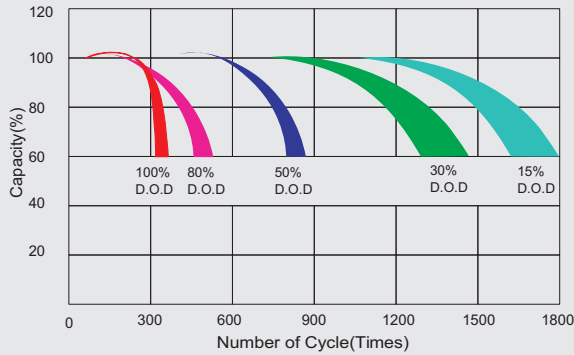

Storage characteristic

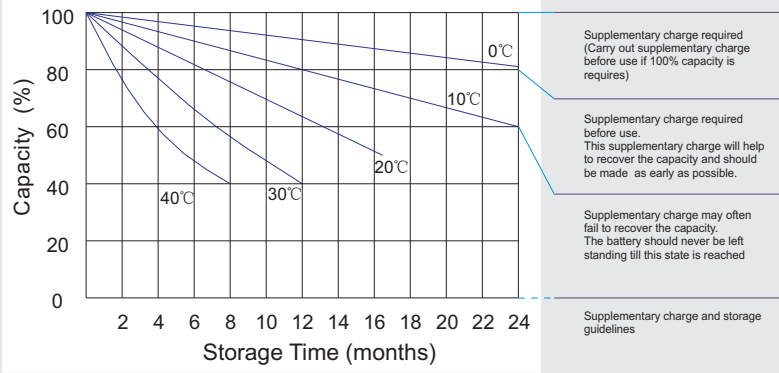

Charge characteristic curve for cyclic use

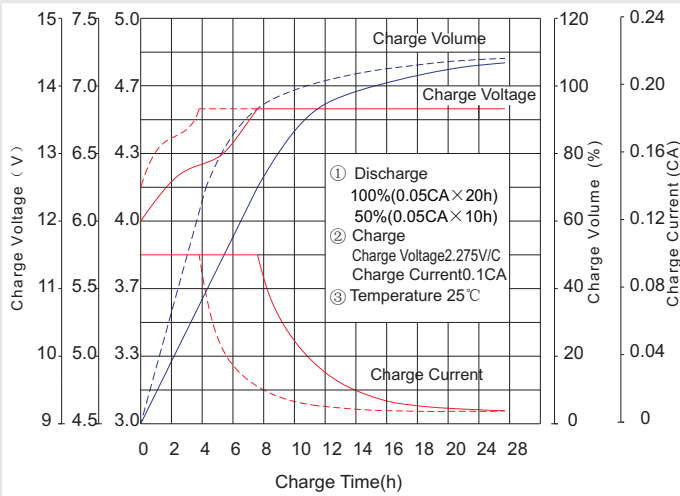

Discharge characteristic curve

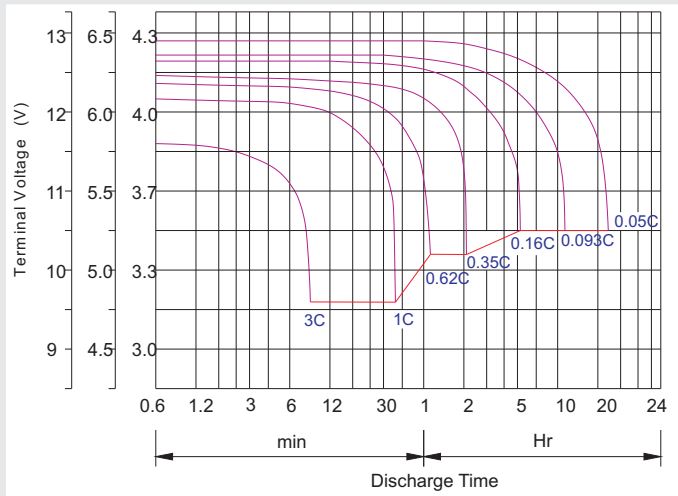

Capacity Factors With Different Temperature

Battery Type		-20°C	-10°C	0°C	5°C	10°C	20°C	25°C	30°C	40°C	45°C
GEL Battery	6V&12V	50%	70%	83%	85%	90%	98%	100%	102%	104%	105%
	2V	60%	75%	85%	88%	92%	99%	100%	103%	105%	106%
AGM Battery	6V&12V	46%	66%	76%	83%	90%	98%	100%	103%	107%	109%
	2V	55%	70%	80%	85%	92%	99%	100%	104%	108%	110%

Discharge Current VS. Discharge Voltage

Final D ischarge Voltage V /cell	1.75V	1.70V	1.60V
Discharge Current (A)	(A) ≤0.2C	0.2C < (A) <1.0C	(A) ≥1.0C

Charge the batteries at least once every six months, if they are stored at 25°C.

Charging Method:

Constant Voltage	-0.2Cx2h+2.4-2.45V/cellx24h, Max. Current 0.3C
Constant Current	-0.2Cx2h+0.1Cx12h
Fast	-0.2Cx2h+0.3Cx4h

Bolt	M5	M6	M8
Terminal	F3 F4 F13 F18 T25 T26	F8 F11 F12-1 F15	F5 F9 F10 F12 F14 F16
Torque	6-7N·m	8-10N·m	10-12N·m

Maintenance & Cautions

Cycle service

- ※ Avoid battery over discharge, especially battery series connection use.
- ※ Charged with recommend voltage, ensure battery can be full recharged.
- In general, recharge capacity should be 1.1-1.15 times discharge capacity.
- ※ Effect of temperature on cycle charge voltage: $-4mV/^\circ C/Cell$.
- ※ There are a number of factors that will affect the length of cyclic service.
- The most significant are depth of discharge, ambient temperature, discharge rate, and the manner in which the battery is recharged.
- Generally speaking, the most important factors is depth of discharge.