



DC12-75A (12V75Ah)

DC (Deep Cycle) series is specially designed for frequent cyclic discharge. By using strong grids and specially designed active material, the DC series battery offers 30% more cyclic life than the standby series. It is suitable for solar energy systems, marine and RV etc.



Specification

Cells Per Unit	6
Voltage Per Unit	12
Capacity	75Ah@10hr-rate to 1.80V per cell @25°C
Weight	Approx. 22.6 Kg(Tolerance ±2%)
Max. Discharge Current	750A (5 sec)
Internal Resistance	Approx. 6.0 mΩ
Operating Temperature Range	Discharge: -20°C~60°C Charge: 0°C~50°C Storage: -20°C~60°C
Normal Operating Temperature Range	25°C ± 5°C
Float charging Voltage	13.6 to 13.8 VDC/unit Average at 25°C
Recommended Maximum Charging Current	22.5 A
Equalization and Cycle Service	14.6 to 14.8 VDC/unit Average at 25°C
Self Discharge	RITAR Valve Regulated Lead Acid (VRLA) batteries can be stored for more than 6 months at 25°C. Self-discharge ratio less than 3% per month at 25°C. Please charge batteries before using.
Terminal	Terminal F11/F15
Container Material	A.B.S. UL94-HB, UL94-V0 Optional.



Dimensions

Unit: mm Dimension: 260(L)×169(W)×235(H)

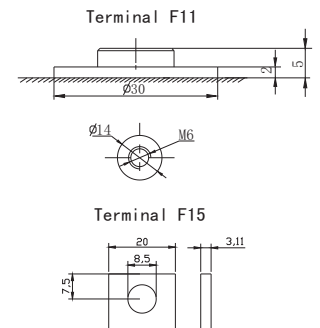
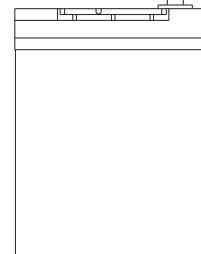
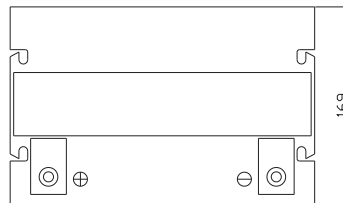
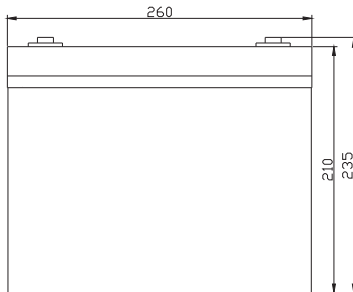

Constant Current Discharge Characteristics: A (25°C)

F.V/Time	5MIN	10MIN	15MIN	30MIN	1HR	2HR	3HR	4HR	5HR	8HR	10HR	20HR
9.60V	249.5	185.6	139.9	73.85	46.81	28.90	19.64	15.84	13.15	8.660	7.804	4.132
10.0V	242.3	176.6	137.0	72.90	46.19	28.32	19.28	15.61	13.03	8.625	7.728	4.055
10.2V	235.1	170.4	134.9	71.79	45.75	28.02	19.11	15.46	12.94	8.548	7.651	3.977
10.5V	211.1	157.2	128.4	69.81	45.19	27.65	18.94	15.23	12.84	8.471	7.575	3.900
10.8V	190.5	143.4	118.4	67.50	44.56	27.43	18.72	14.71	12.77	8.437	7.506	3.861
11.1V	162.7	128.1	106.2	64.94	43.51	26.32	18.35	14.50	12.68	8.369	7.419	3.704

Constant Power Discharge Characteristics: W(25°C)

F.V/Time	5MIN	10MIN	15MIN	30MIN	1HR	2HR	3HR	4HR	5HR	8HR	10HR	20HR
9.60V	2632	1977	1525	845.3	542.5	338.7	231.2	189.6	157.5	103.7	93.59	49.77
10.0V	2580	1916	1501	836.5	537.5	334.6	227.8	186.9	156.1	103.3	92.85	48.91
10.2V	2551	1866	1484	829.3	534.4	332.2	226.8	185.2	155.1	102.5	92.03	48.00
10.5V	2322	1737	1415	812.4	530.9	328.0	225.0	182.7	153.9	101.7	91.12	47.09
10.8V	2115	1601	1308	793.1	524.1	325.5	222.4	176.5	153.2	101.2	90.22	46.64
11.1V	1858	1448	1178	771.4	516.3	313.3	218.7	174.0	152.6	100.5	89.24	44.97

All mentioned values are average values (Tolerance ±2%).

DC12-75A

12V75Ah

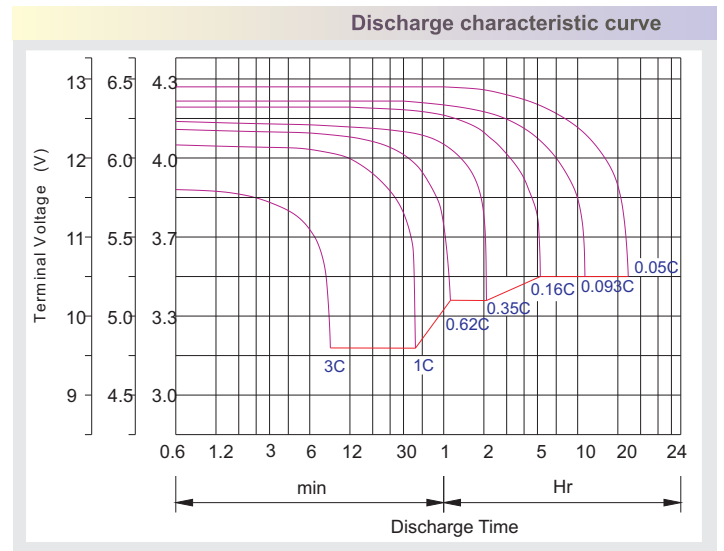
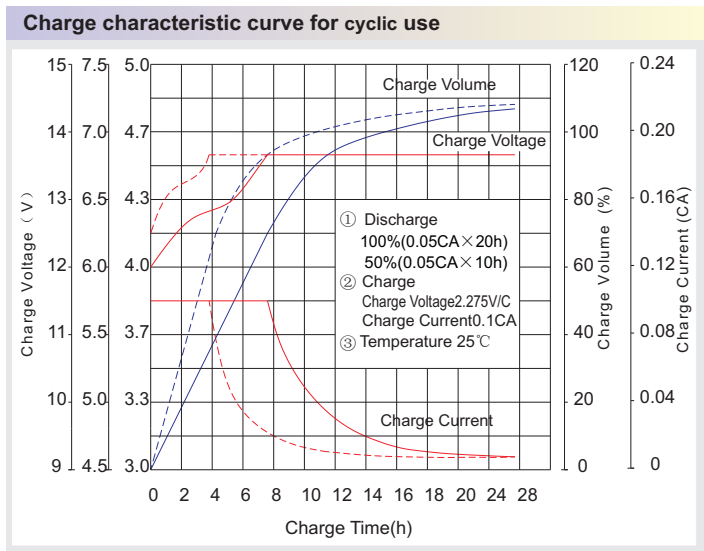
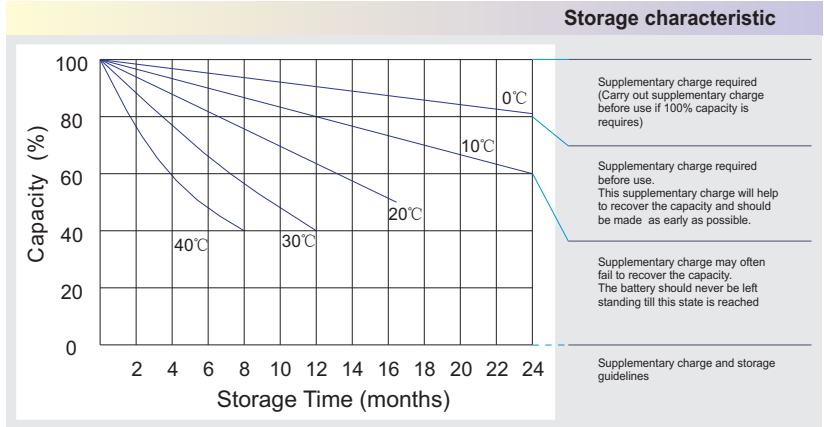
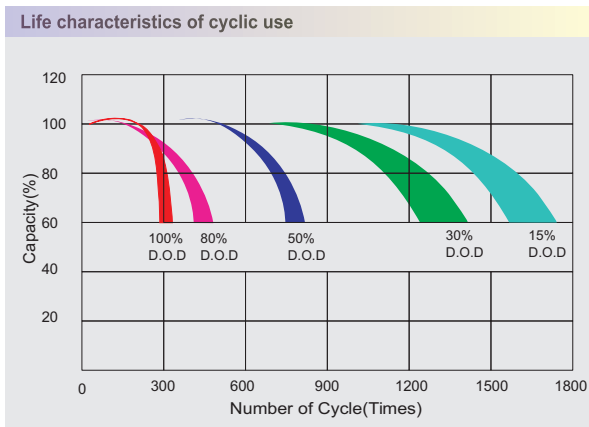

Capacity Factors With Different Temperature

Battery Type		-20°C	-10°C	0°C	5°C	10°C	20°C	25°C	30°C	40°C	45°C
GEL Battery	6V&12V	50%	70%	83%	85%	90%	98%	100%	102%	104%	105%
	2V	60%	75%	85%	88%	92%	99%	100%	103%	105%	106%
AGM Battery	6V&12V	46%	66%	76%	83%	90%	98%	100%	103%	107%	109%
	2V	55%	70%	80%	85%	92%	99%	100%	104%	108%	110%

Discharge Current VS. Discharge Voltage

Final D ischarge Voltage V /cell	1.75V	1.70V	1.60V
Discharge Current (A)	(A) ≤0.2C	0.2C < (A) < 1.0C	(A) ≥1.0C

Charge the batteries at least once every six months, if they are stored at 25°C.

Charging Method:

Constant Voltage	-0.2Cx2h+2.4-2.45V/cellx24h, Max. Current 0.3C
Constant Current	-0.2Cx2h+0.1Cx12h
Fast	-0.2Cx2h+0.3Cx4h

Bolt	M5	M6	M8
Terminal	F3 F4 F13 F18 T25 T26	F8 F11 F12-1 F15	F5 F9 F10 F12 F14 F16
Torque	6-7N·m	8-10N·m	10-12N·m

Maintenance & Cautions

Cycle service
※ Avoid battery over discharge, especially battery series connection use.
※ Charged with recommend voltage, ensure battery can be full recharged.
In general, recharge capacity should be 1.1-1.15 times discharge capacity
※ Effect of temperature on cycle charge voltage: -4mV/°C/Cell.
※ There are a number of factors that will affect the length of cyclic service.
The most significant are depth of discharge, ambient temperature, discharge rate, and the manner in which the battery is recharged.
Generally speaking, the most important factors is depth of discharge.