



DC2-800A (2V800Ah)

DC (Deep Cycle) series is specially designed for frequent cyclic discharge. By using strong grids and specially designed active material, the DC series battery offers 30% more cyclic life than the standby series. It is suitable for solar energy systems, marine and RV etc.



Specification

Cells Per Unit	1
Voltage Per Unit	2
Capacity	800Ah@10hr-rate to 1.80V per cell @25°C
Weight	Approx.50.0Kg(Tolerance $\pm 1.5\%$)
Max. Discharge Current	3200 A (5 sec)
Internal Resistance	Approx. 0.6 m Ω
Operating Temperature Range	Discharge: -20°C~60°C Charge: 0°C~50°C Storage: -20°C~60°C
Normal Operating Temperature Range	25°C \pm 5°C
Float charging Voltage	2.27 to 2.3 VDC/unit Average at 25°C
Recommended Maximum Charging Current	160 A
Equalization and Cycle Service	2.43 to 2.47 VDC/unit Average at 25°C
Self Discharge	RITAR Valve Regulated Lead Acid (VRLA) batteries can be stored for more than 6 months at 25°C. Self-discharge ratio less than 3% per month at 25°C. Please charge batteries before using.
Terminal	Thread insert & Bolt (F10)
Container Material	A.B.S. UL94-HB, UL94-V0 Optional.



Dimensions

Unit: mm Dimension: 380(L) \times 171(W) \times 330(342)(H)

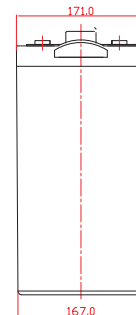
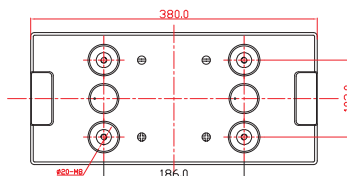
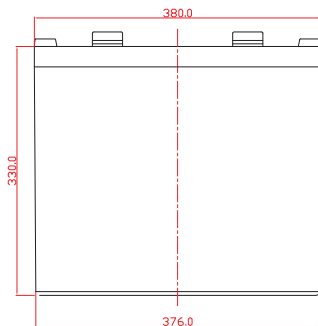

F10 Terminal

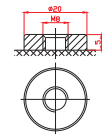

Constant Current Discharge Characteristics : A(25°C)

F.V/Time	15MIN	30MIN	1HR	2HR	3HR	4HR	5HR	6HR	8HR	10HR
1.60V	1086	801.0	499.5	306.4	228.2	163.7	143.3	128.7	103.9	83.32
1.65V	1033	769.1	493.2	295.3	218.7	158.0	141.9	125.6	99.23	82.53
1.70V	963.1	725.0	483.6	290.5	213.9	156.6	139.9	122.5	97.68	81.74
1.75V	855.0	652.5	445.3	274.5	202.7	147.9	138.1	116.3	94.57	80.86
1.80V	736.0	594.3	419.7	261.7	194.7	146.5	135.7	114.7	93.02	80.11
1.85V	622.4	535.0	387.8	247.4	185.1	135.0	127.7	108.5	88.37	75.22

Constant Power Discharge Characteristics : W(25°C)

F.V/Time	15MIN	30MIN	1HR	2HR	3HR	4HR	5HR	6HR	8HR	10HR
1.60V	1902	1460	929.5	573.3	425.3	307.7	285.0	248.3	197.7	166.0
1.65V	1852	1452	924.6	565.1	417.0	303.1	282.3	245.1	196.0	164.4
1.70V	1749	1374	915.5	556.8	410.6	302.0	279.0	239.4	193.0	163.5
1.75V	1558	1238	858.7	527.1	395.9	286.8	275.0	227.6	186.9	161.8
1.80V	1349	1130	816.6	503.4	379.5	285.5	270.2	224.9	183.9	160.5
1.85V	1150	1019	757.5	476.5	361.5	264.4	255.0	213.1	174.7	151.2

All mentioned values are average values (Tolerance $\pm 2\%$).

DC2-800A

2V800Ah



Life characteristics of cyclic use

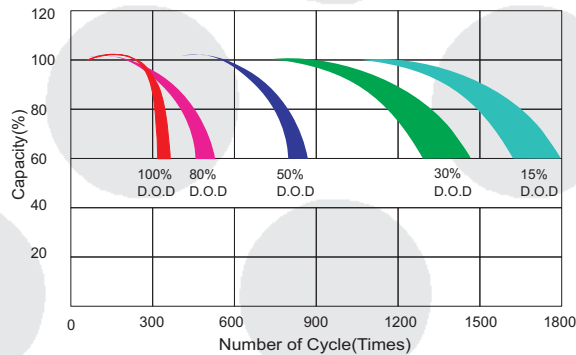

Storage characteristic

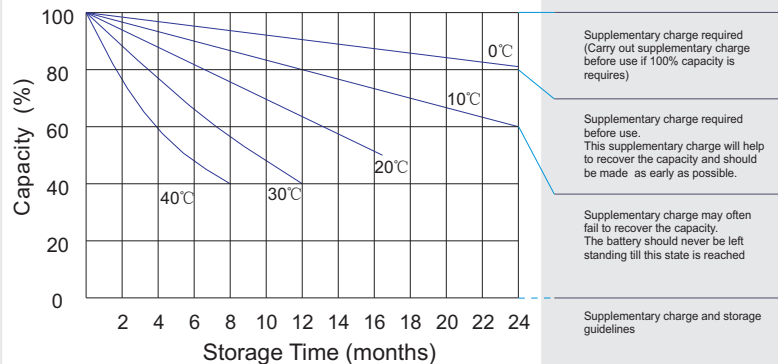

Charge characteristic Curve for standby use

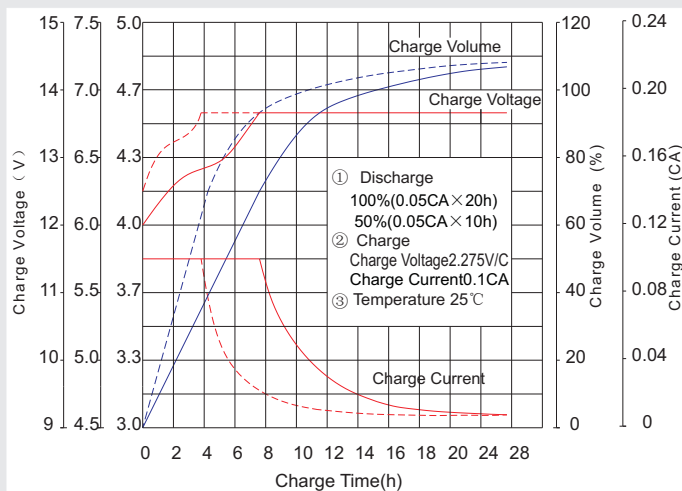

Discharge characteristic curve

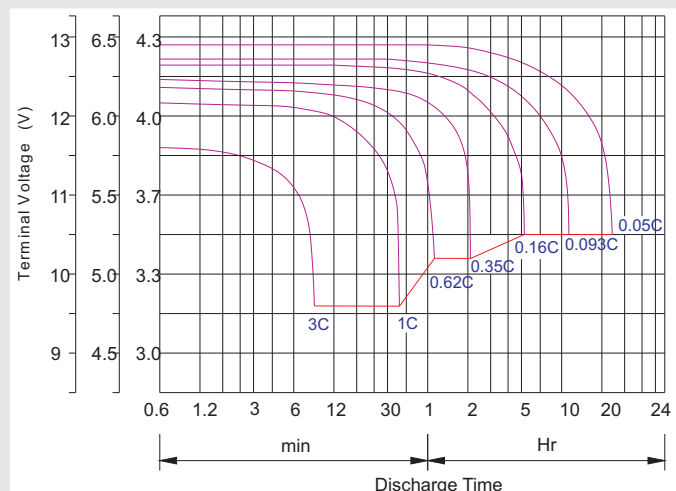

Capacity Factors With Different Temperature

Battery Type		-20°C	-10°C	0°C	5°C	10°C	20°C	25°C	30°C	40°C	45°C
GEL Battery	6V&12V	50%	70%	83%	85%	90%	98%	100%	102%	104%	105%
	2V	60%	75%	85%	88%	92%	99%	100%	103%	105%	106%
AGM Battery	6V&12V	46%	66%	76%	83%	90%	98%	100%	103%	107%	109%
	2V	55%	70%	80%	85%	92%	99%	100%	104%	108%	110%

Discharge Current VS. Discharge Voltage

Final Discharge Voltage V /cell	1.75V	1.70V	1.60V
Discharge Current (A)	(A) ≤ 0.2C	0.2C < (A) < 1.0C	(A) ≥ 1.0C

Charge the batteries at least once every six months, if they are stored at 25°C.

Charging Method:

Constant Voltage	-0.2Cx2h+2.4-2.45V/cellx24h, Max. Current 0.2C
Constant Current	-0.2Cx2h+0.1Cx12h
Fast	-0.2Cx2h+0.2Cx6h

Bolt	M5	M6	M8
Terminal	F3 F4 F13 F18 T25 T26	F8 F11 F12-1 F15	F5 F9 F10 F12 F14 F16
Torque	6~7N·m	8~10N·m	10~12N·m

Maintenance & Cautions

Cycle service

- ※ Avoid battery over discharge, especially battery series connection use.
- ※ Charged with recommend voltage, ensure battery can be full recharged.
- In general, recharge capacity should be 1.1-1.15 times discharge capacity.
- ※ Effect of temperature on cycle charge voltage: -4mV/°C/Cell.
- ※ There are a number of factors that will affect the length of cyclic service.
- The most significant are depth of discharge, ambient temperature, discharge rate, and the manner in which the battery is recharged.
- Generally specking, the most important factors is depth of discharge.