



EV12-75 (12V75Ah)

EV (Electric Vehicle) series is specially designed for frequent deep cycle discharge. By using the specially designed active material and strong grids, the EV series battery offers reliable performance in high load situations and can deliver more than 300 cycles at 100% DOD. Suitable for mobility scooters, electric wheel chairs, golf buggies etc.



Specification

| | |
|--|---|
| Cells Per Unit | 6 |
| Voltage Per Unit | 12 |
| Capacity | 75Ah@10hr-rate to 1.80V per cell @25°C |
| Weight | Approx. 23.5 Kg(Tolerance ±2%) |
| Max. Discharge Current | 750 A (5 sec) |
| Internal Resistance | Approx. 6 mΩ |
| Operating Temperature Range | Discharge: -20°C~60°C Charge: 0°C~50°C Storage: -20°C~60°C |
| Normal Operating Temperature Range | 25°C ± 5°C |
| Float charging Voltage | 13.6 to 13.8 VDC/unit Average at 25°C |
| Recommended Maximum Charging Current Limit | 22.5 A |
| Equalization and Cycle Service | 14.6 to 14.8 VDC/unit Average at 25°C |
| Self Discharge | RITAR Valve Regulated Lead Acid (VRLA) batteries can be stored for more than 6 months at 25°C. Self-discharge ratio less than 3% per month at 25°C. Please charge batteries before using. |
| Terminal | Terminal F11/F15 |
| Constainer Material | A.B.S. UL94-HB, UL94-V0 Optional. |



Dimensions

Unit: mm Dimension: 260(L) × 169(W) × 235 (H)

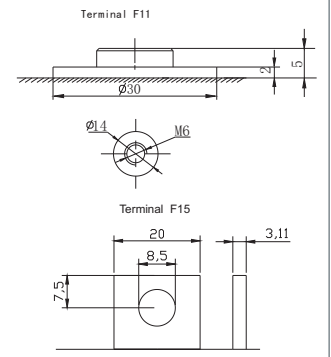
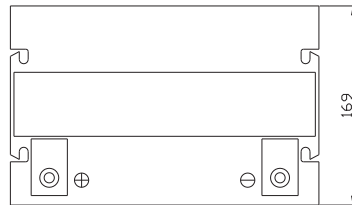
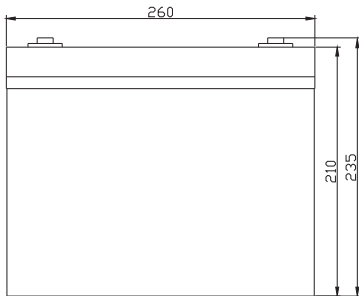

Constant Current Discharge Characteristics: A(25°C)

| F.V/Time | 5MIN | 10MIN | 15MIN | 30MIN | 1HR | 2HR | 3HR | 4HR | 5HR | 8HR | 10HR | 20HR |
|----------|-------|-------|-------|-------|-------|-------|-------|-------|-------|------|------|------|
| 9.60V | 246.3 | 181.3 | 141.3 | 86.14 | 47.78 | 28.57 | 19.73 | 16.34 | 13.76 | 9.40 | 7.80 | 4.16 |
| 10.0V | 239.2 | 172.5 | 138.4 | 84.65 | 47.55 | 28.36 | 19.65 | 16.27 | 13.68 | 9.32 | 7.72 | 4.08 |
| 10.2V | 232.1 | 166.4 | 136.3 | 83.08 | 47.11 | 28.14 | 19.50 | 16.19 | 13.60 | 9.25 | 7.65 | 4.01 |
| 10.5V | 208.4 | 153.6 | 129.8 | 82.46 | 46.67 | 27.93 | 19.43 | 16.04 | 13.44 | 9.17 | 7.57 | 3.93 |
| 10.8V | 188.1 | 140.0 | 119.6 | 81.05 | 45.57 | 27.43 | 18.90 | 15.66 | 13.19 | 9.02 | 7.50 | 3.86 |
| 11.1V | 160.6 | 125.2 | 107.3 | 75.88 | 43.29 | 26.21 | 18.07 | 14.91 | 12.63 | 8.63 | 7.27 | 3.63 |

Constant Power Discharge Characteristics: W(25°C)

| F.V/Time | 5MIN | 10MIN | 15MIN | 30MIN | 1HR | 2HR | 3HR | 4HR | 5HR | 8HR | 10HR | 20HR |
|----------|------|-------|-------|-------|-------|-------|-------|-------|-------|-------|-------|-------|
| 9.60V | 2598 | 1931 | 1541 | 966.5 | 552.1 | 336.8 | 234.8 | 194.8 | 164.1 | 112.2 | 93.15 | 49.87 |
| 10.0V | 2547 | 1872 | 1516 | 954.7 | 550.7 | 335.0 | 234.9 | 194.6 | 163.7 | 111.7 | 92.57 | 49.01 |
| 10.2V | 2518 | 1822 | 1499 | 948.0 | 546.5 | 333.0 | 233.8 | 194.1 | 163.2 | 110.9 | 91.75 | 48.10 |
| 10.5V | 2292 | 1697 | 1430 | 941.4 | 541.6 | 330.5 | 232.9 | 192.3 | 161.2 | 110.0 | 90.85 | 47.19 |
| 10.8V | 2088 | 1564 | 1322 | 926.3 | 531.6 | 326.3 | 226.6 | 187.9 | 158.3 | 108.2 | 89.95 | 46.28 |
| 11.1V | 1834 | 1414 | 1190 | 872.5 | 508.8 | 314.2 | 216.8 | 178.9 | 151.5 | 103.6 | 87.25 | 43.56 |

All mentioned values are average values (Tolerance ±2%).

EV12-75

12V75Ah



Life characteristics of cyclic use

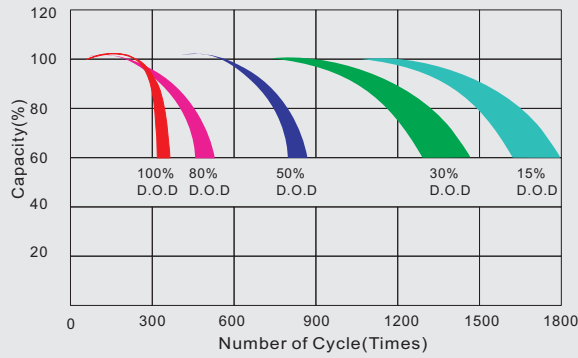

Storage characteristic

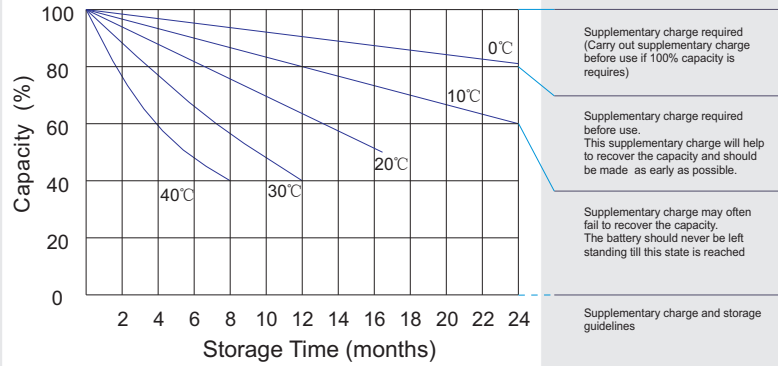

Charge characteristic Curve for standby use

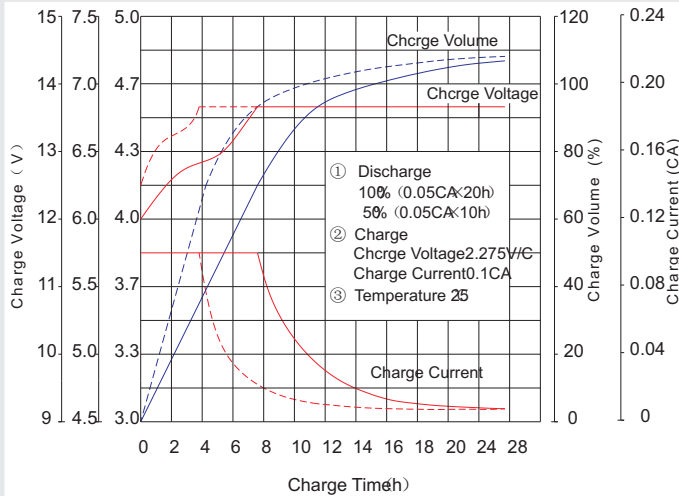

Discharge characteristic Curve

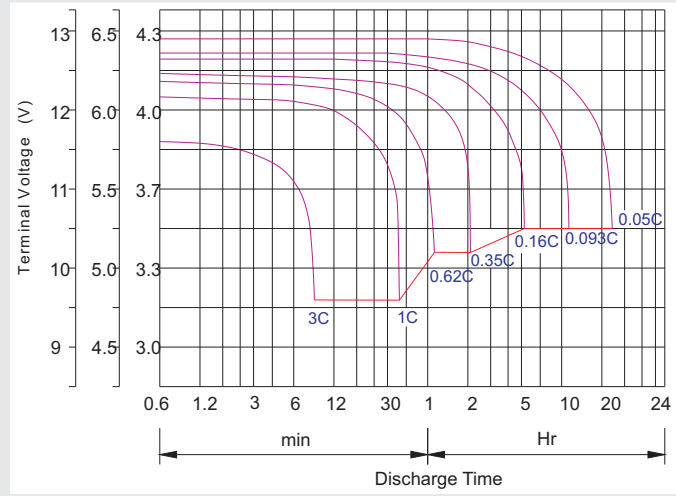

Capacity Factors With Different Temperature

| Battery Type | | -20°C | -10°C | 0°C | 5°C | 10°C | 20°C | 25°C | 30°C | 40°C | 45°C |
|--------------|--------|-------|-------|-----|-----|------|------|------|------|------|------|
| GEL Battery | 6V&12V | 50% | 70% | 83% | 85% | 90% | 98% | 100% | 102% | 104% | 105% |
| | 2V | 60% | 75% | 85% | 88% | 92% | 99% | 100% | 103% | 105% | 106% |
| AGM Battery | 6V&12V | 46% | 66% | 76% | 83% | 90% | 98% | 100% | 103% | 107% | 109% |
| | 2V | 55% | 70% | 80% | 85% | 92% | 99% | 100% | 104% | 108% | 110% |

Discharge Current VS. Discharge Voltage

| Final D ischarge Voltage V /cell | 1.75V | 1.70V | 1.60V |
|----------------------------------|------------|-------------------|------------|
| Discharge Current (A) | (A) ≤ 0.2C | 0.2C < (A) < 1.0C | (A) ≥ 1.0C |

Charge the batteries at least once every six months, if they are stored at 25°C.

Charging Method:

| | |
|------------------|--|
| Constant Voltage | -0.2Cx2h+2.4-2.45V/cellx24h, Max. Current 0.3C |
| Constant Current | -0.2Cx2h+0.1Cx12h |
| Fast | -0.2Cx2h+0.3Cx4h |

Maintenance & Cautions

Cycle service

- ※ Avoid battery over discharge, especially battery series connection use.
- ※ Charged with recommend voltage, ensure battery can be full recharged.
- In general, recharge capacity should be 1.1-1.15 times discharge capacity.
- ※ Effect of temperature on cycle charge voltage: -4mV/°C/Cell.
- ※ There are a number of factors that will affect the length of cyclic service.
- The most significant are depth of discharge, ambient temperature, discharge rate, and the manner in which the battery is recharged.
- Generally speaking, the most important factors is depth of discharge.

| Bolt | M5 | M6 | M8 |
|----------|-----------------------|------------------|-----------------------|
| Terminal | F3 F4 F13 F18 T25 T26 | F8 F11 F12-1 F15 | F5 F9 F10 F12 F14 F16 |
| Torque | 6-7N·m | 8-10N·m | 10-12N·m |